

Instalation manual

SOLO: KOM_3D3S

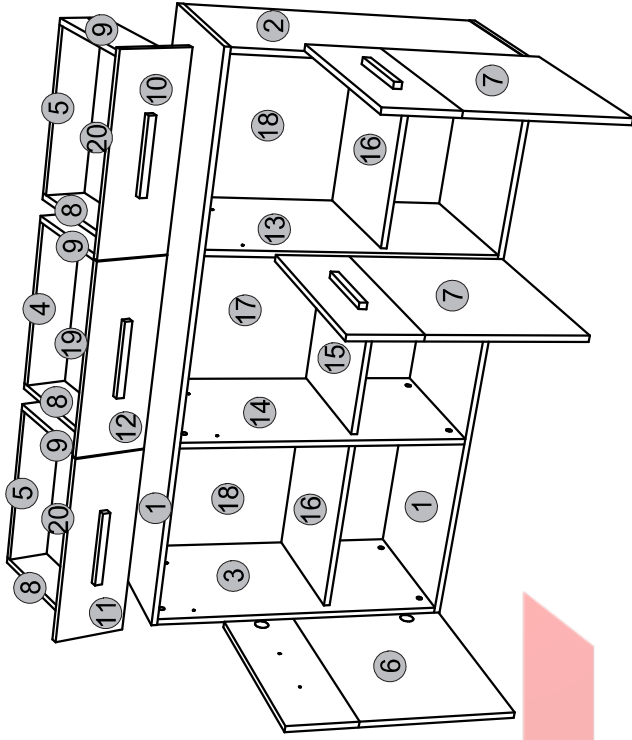

Element symbol	Dimensions	Code	Package
1	1500 394 16	SN-210	1/1
2	762 394 16	SN-125	1/1
3	762 394 16	SN-126	1/1
4	427 120 16	SN-413	1/1
5	417 120 16	SN-414	1/1
6	597 498 16	SN-031	2/2
7	597 498 16	SN-032	2/2
8	350 120 16	SN-415	1/1
9	350 120 16	SN-416	1/1
10	498 188 16	SN-028	2/2
11	498 188 16	SN-029	2/2
12	498 188 16	SN-030	2/2
13	762 391 16	SN-127	1/1
14	762 391 16	SN-128	1/1
15	484 356 16	SN-313	1/1
16	474 356 16	SN-314	1/1
17	777 500 3	SN-616	3/3
18	777 491 3	SN-617	3/3
19	441 348 3	SN-618	3/3
20	431 348 3	SN-619	3/3

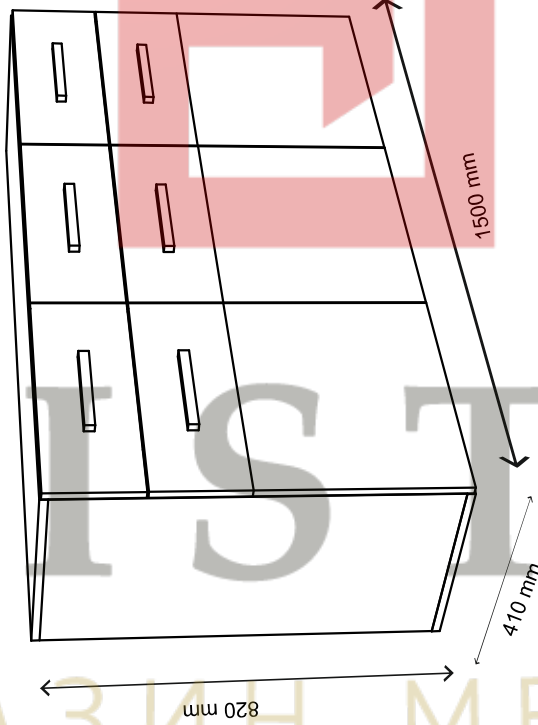
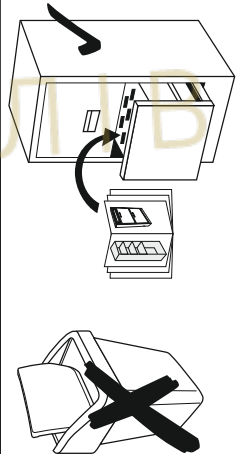
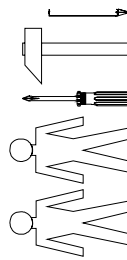
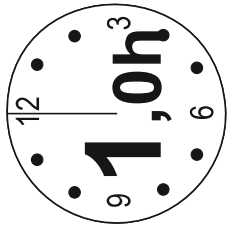
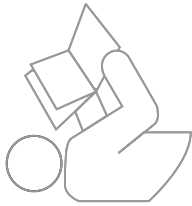
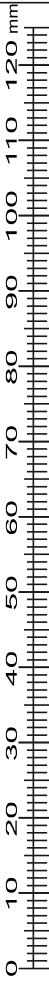
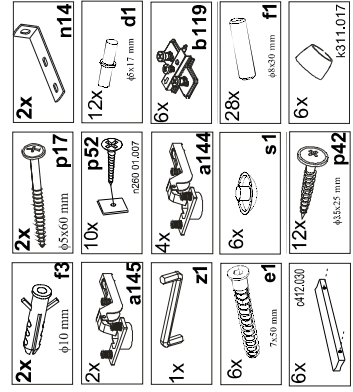

1

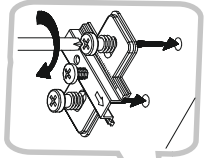
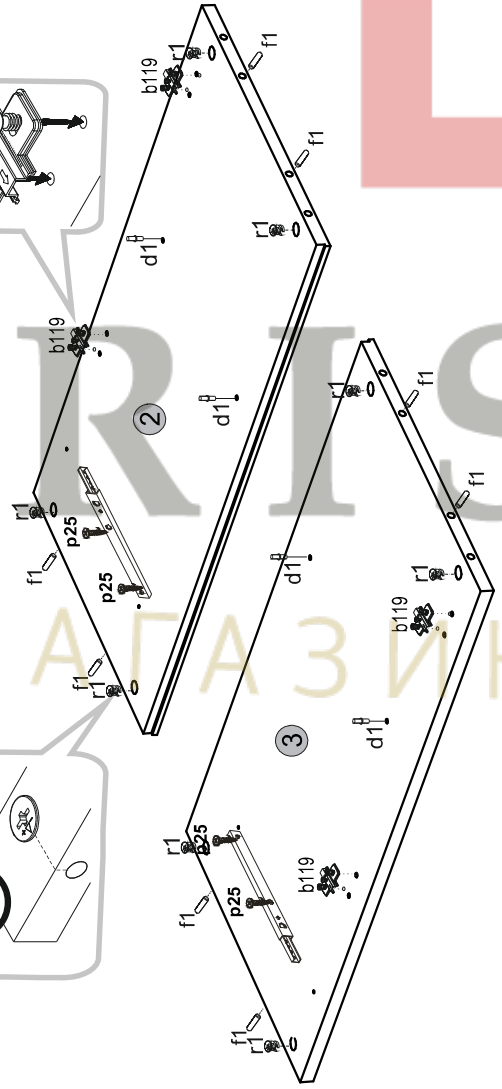
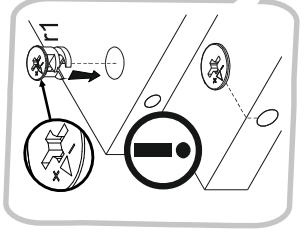

3

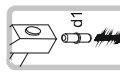
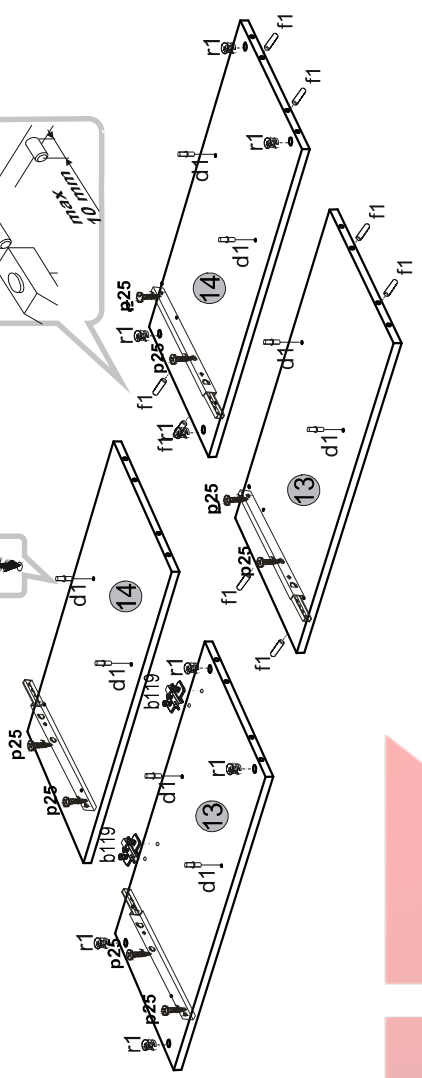
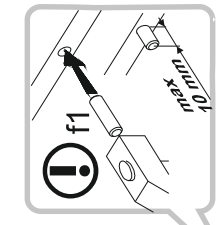

2

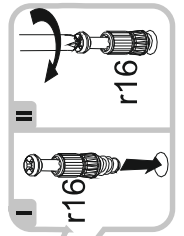
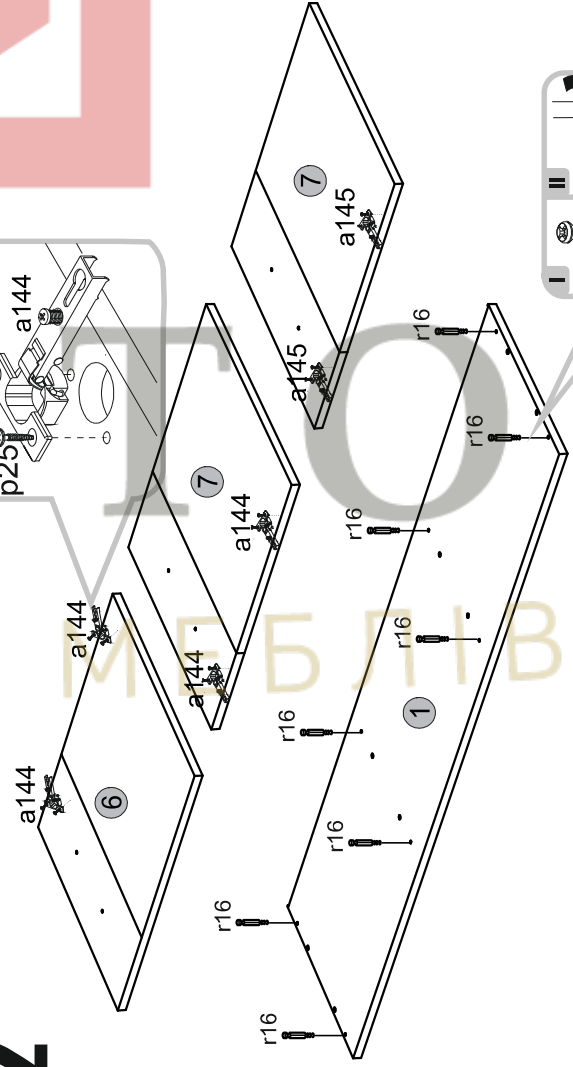
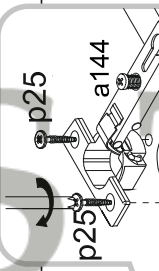

4

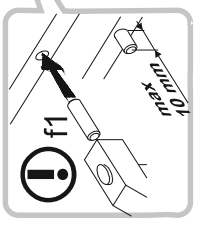
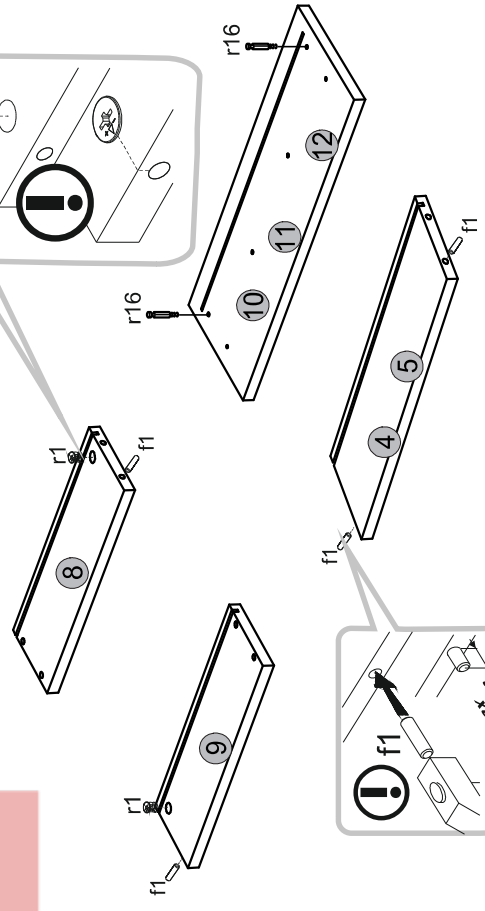
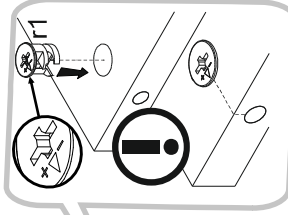

5

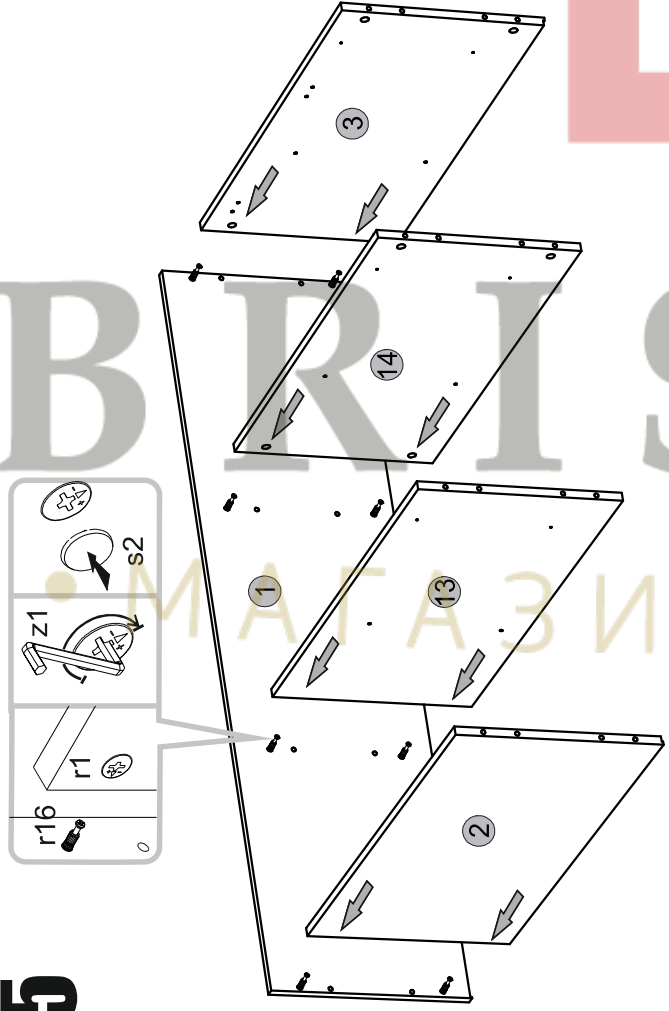

7

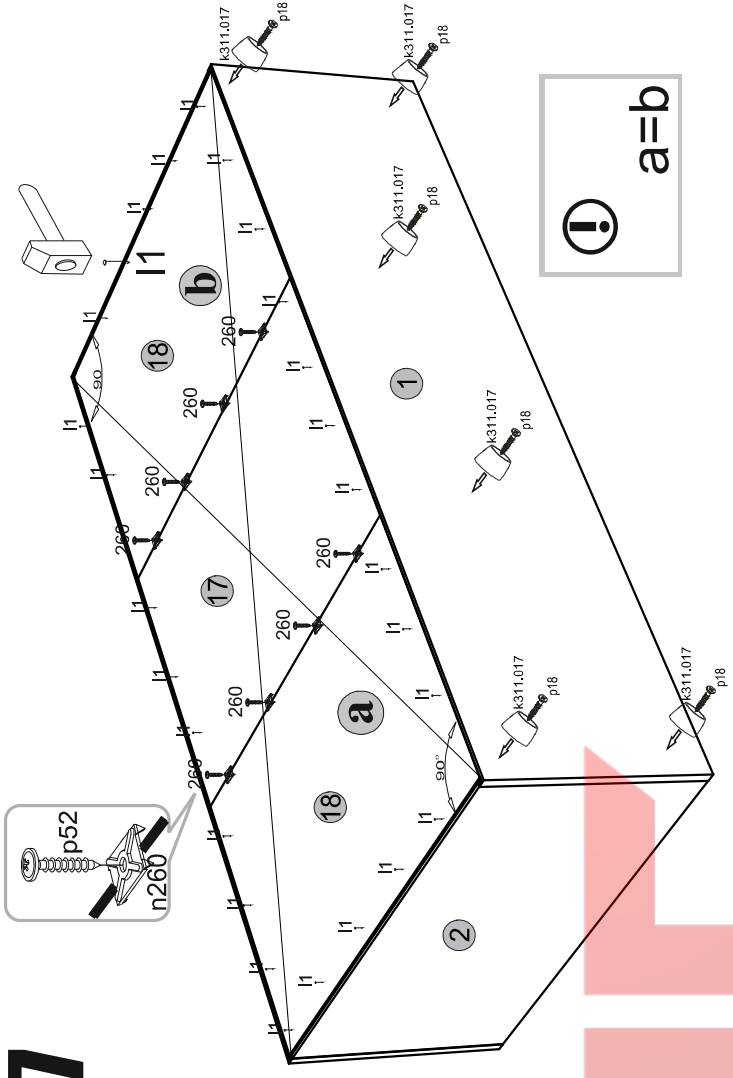

6

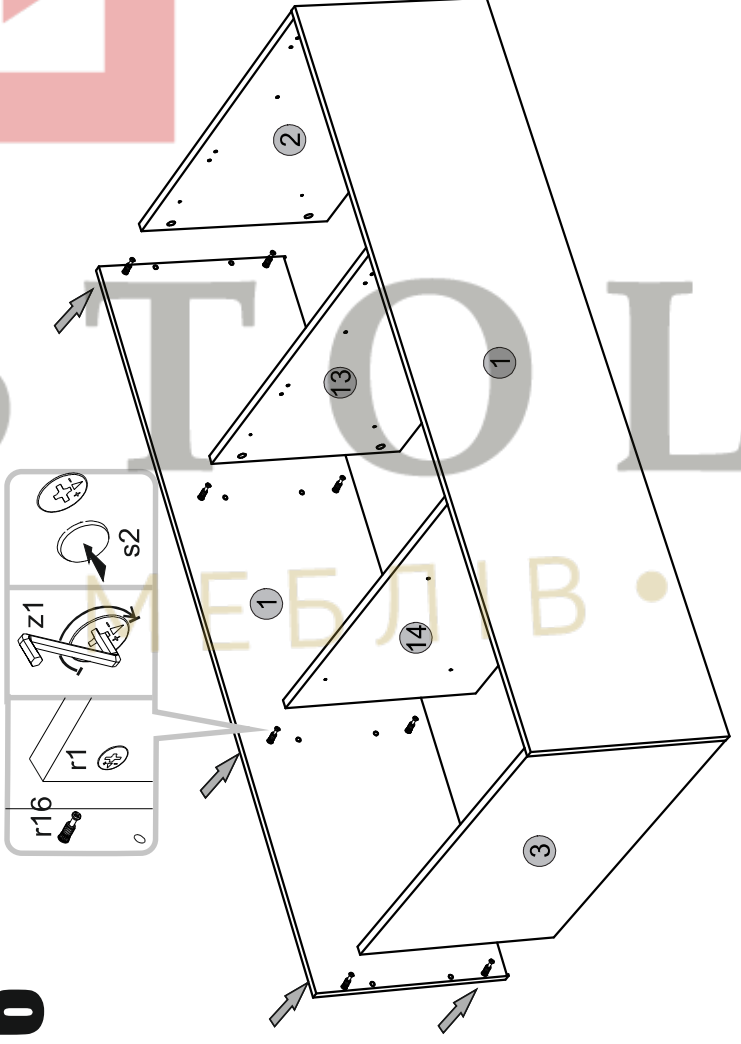

8

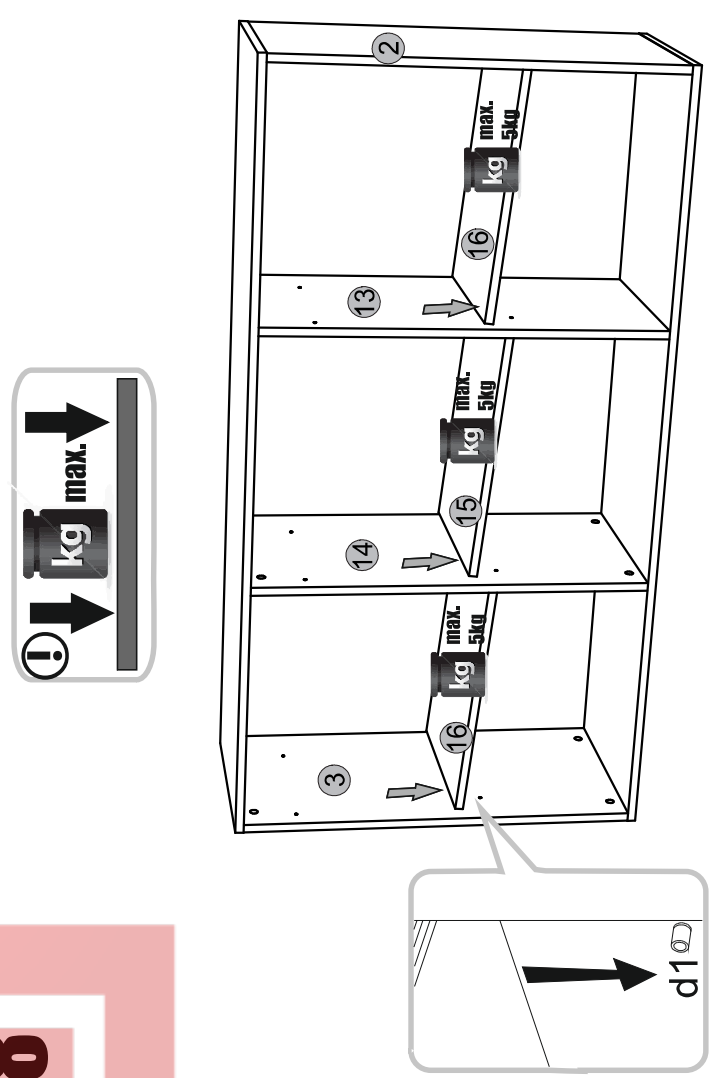

11

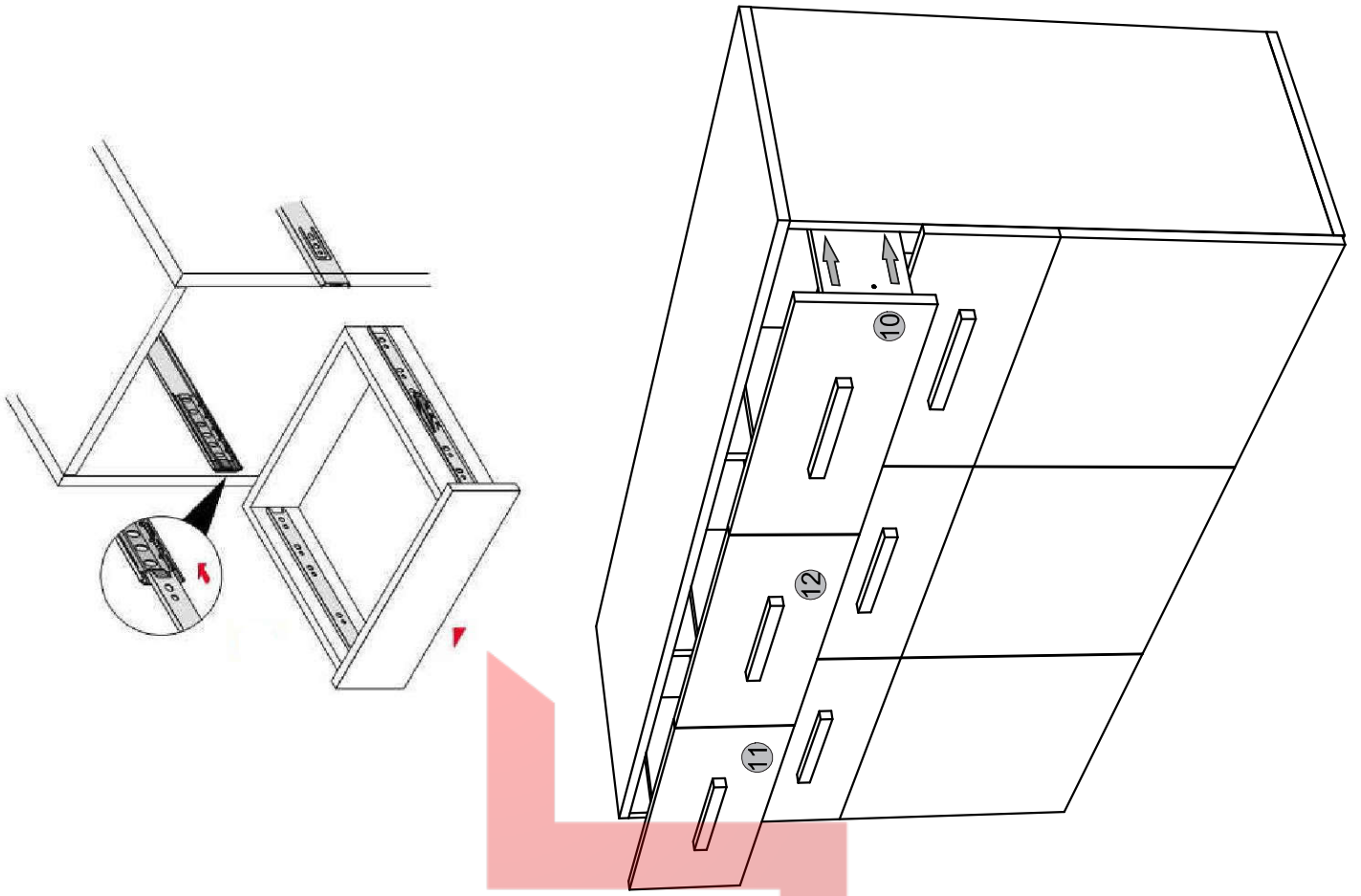

9

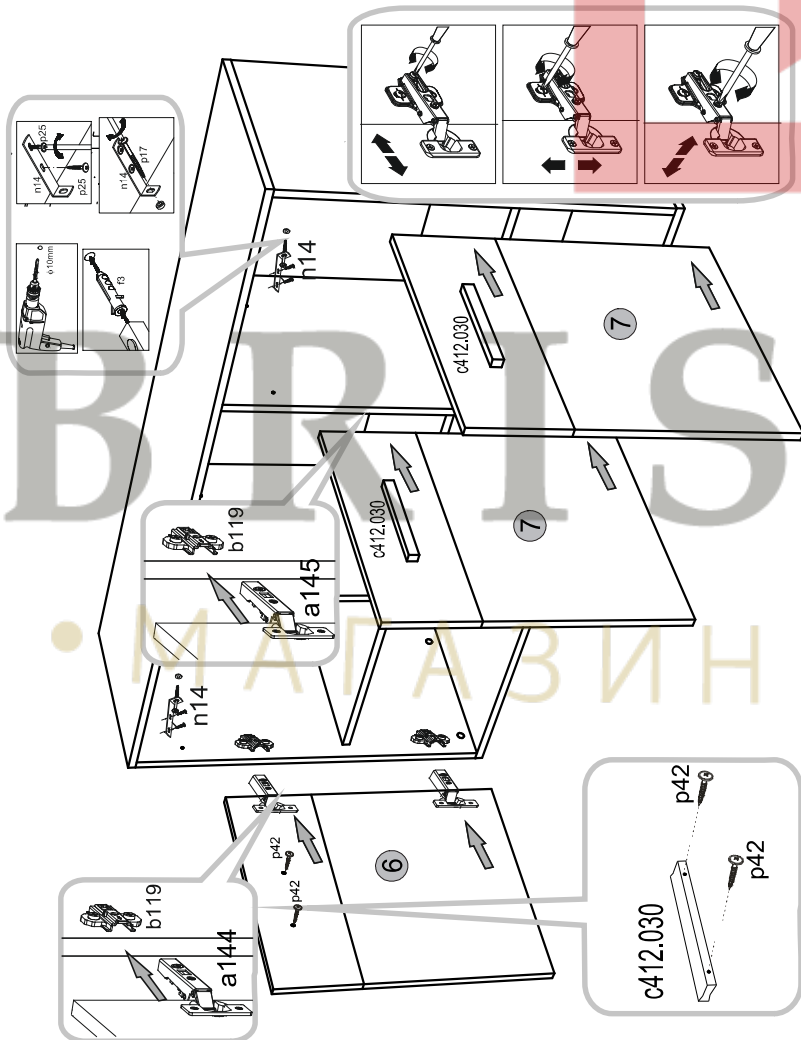

10

