

PRZED ROZPOCZĘCIEM MONTAŻU ZAPOZNAĆ SIĘ Z INSTRUKCJĄ

Narzędzia niezbędne do montażu (nie dostarczane przez producenta)

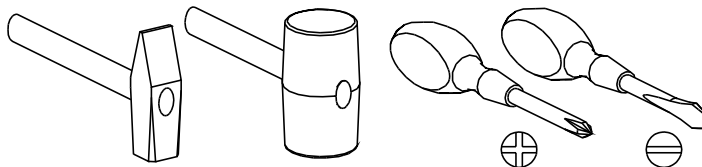
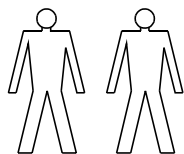

LARSA

REG_1W_1D

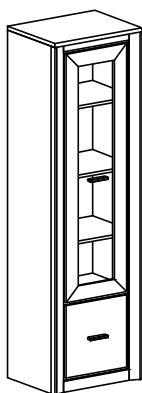

Nr	Nazwa elementu	Dł [mm]	Szer [mm]	Gr [mm]	Ilość	Kod	Paczka
1	wieniec środkowy	532	397	16	1		2/4
2	wieniec dolny	532	397	16	1		2/4
3	listwa pion. dolna L	397	70	16	1		1/4
4	listwa pion. górna L	1362	70	16	1		1/4
5	blat	565	432	22	1		2/4
6	listwa górna	532	54	16	1		1/4
7	bok lewy	1906	400	16	1		1/4
8	bok prawy	1906	400	16	1		1/4
9	półka	532	380	16	1		2/4
10	cokół tylny	532	60	16	1		1/4
11	listwa MDF lewa	1906	70	32	1		1/4
12	listwa MDF prawa	1906	70	32	1		1/4
13	listwa górna przednia	424	38	16	1		1/4
14	HDF ściany tylnej	1855	275	2,5	2		1/4
15	listwa dolna przednia	424	60	16	1		1/4
16	drzwi dolne	403	398	16	1		1/4
18	ramka MDF	1369	398	16	1		3/4
19	szyba	1271	299	4	1		3/4
20	listwa pion. górna P	1362	70	16	1		1/4
21	listwa pion. dolna P	397	70	16	1		1/4
22	półki z frezem	532	380	16	2		2/4

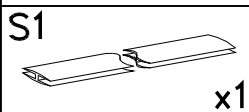
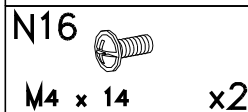
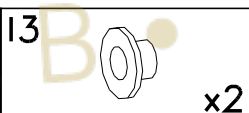
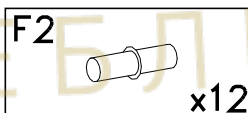
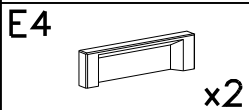
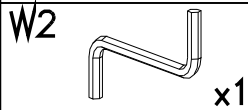
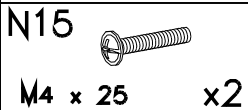
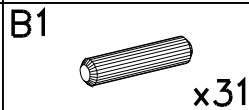
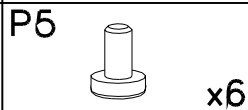
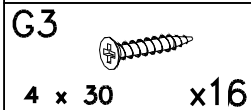
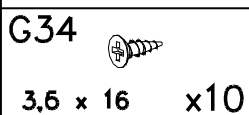
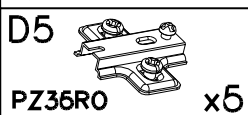
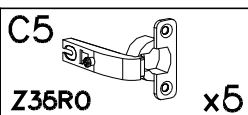
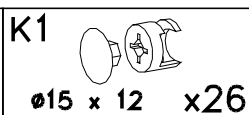
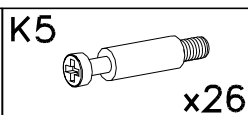
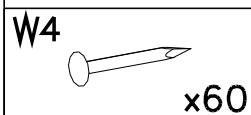

I

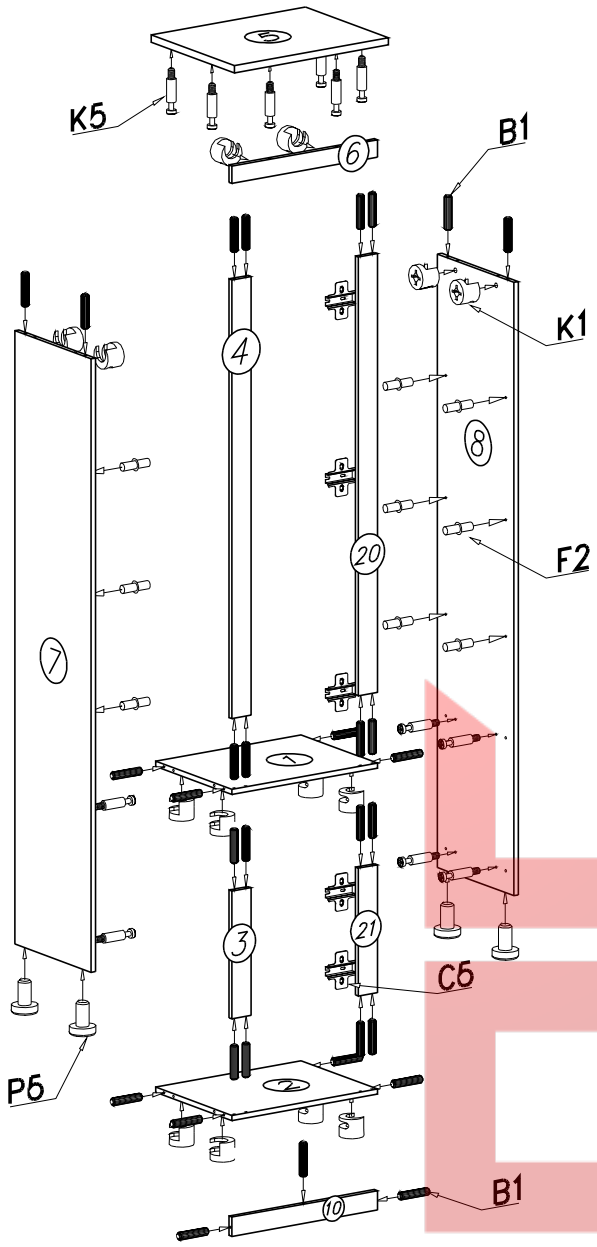

III

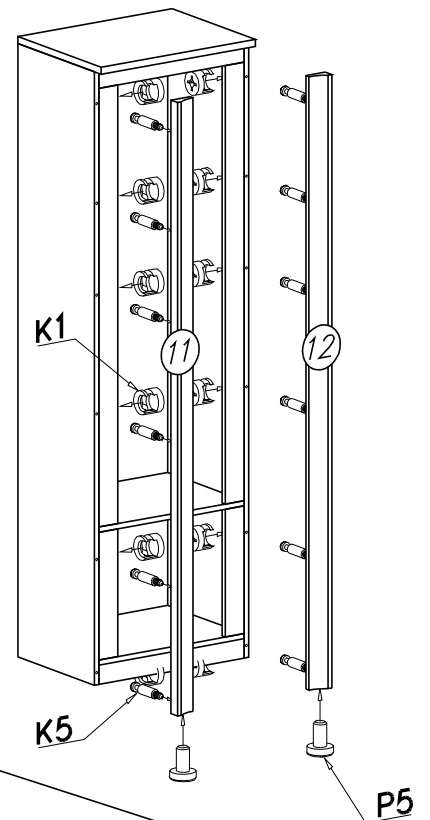

IV

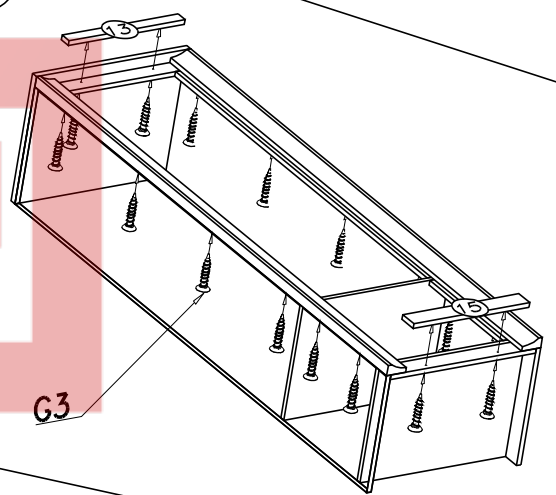

II



V

Opcja: drzwi lewe

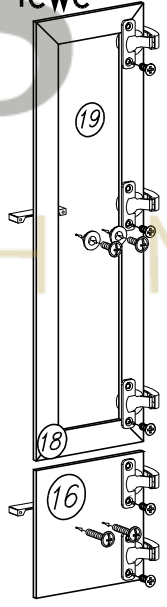

Opcja: drzwi prawe

