

PRZED ROZPOCZĘCIEM MONTAŻU ZAPOZNAĆ SIĘ Z INSTRUKCJĄ

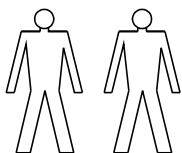

Narzędzia niezbędne do montażu (nie dostarczane przez producenta)

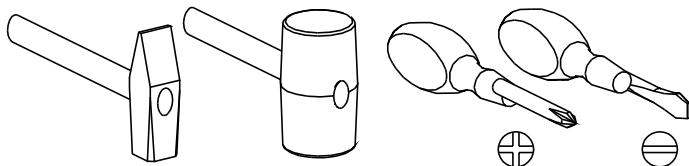

LARSA

KOM_5S

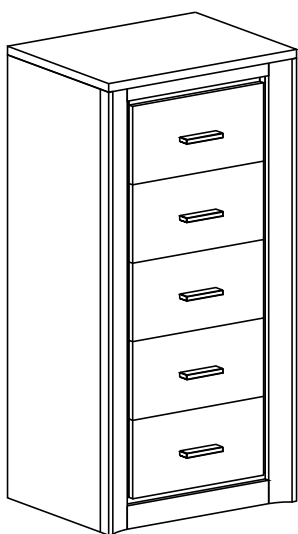

Nr	Nazwa elementu	Dł [mm]	Szer [mm]	Gr [mm]	Ilość	Kod	Paczka
1	blat	565	432	22	1		1/2
2	listwa górna	394	54	16	1		2/2
3	wieniec dolny	532	397	16	1		1/2
4	bok lewy	1134	400	16	1		2/2
5	bok prawy	1134	400	16	1		2/2
6	przegroda lewa	1057	397	16	1		1/2
7	przegroda prawa	1057	397	16	1		1/2
8	cokół tylny	532	60	16	1		2/2
9	front szuflady	399	200	16	5		2/2
10	HDF szuflady	350	356	2,5	5		2/2
11	tył szuflady	334	120	16	5		2/2
12	bok szuflady lewy	350	140	16	5		2/2
13	bok szuflady prawy	350	140	16	5		2/2
14	HDF ściany tylnej	1085	276	2,5	2		1/2
15	listwa MDF lewa	1134	70	32	1		2/2
16	cokół przedni	424	60	16	1		2/2
17	listwa MDF prawa	1134	70	32	1		2/2
18	listwa przednia górna	424	38	16	1		2/2

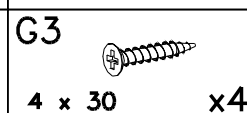
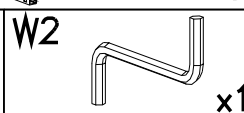
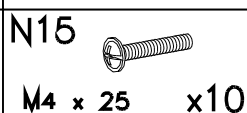
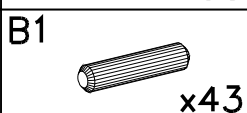
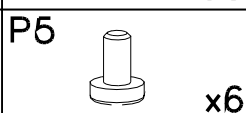
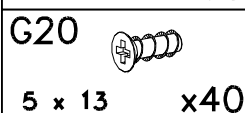
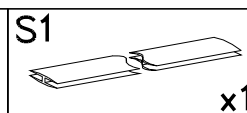
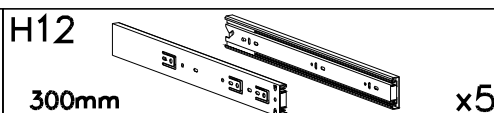
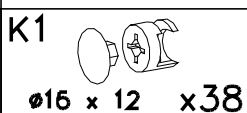
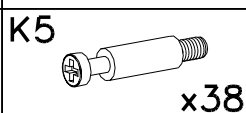
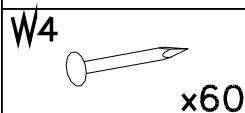
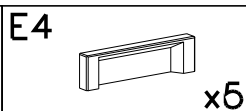
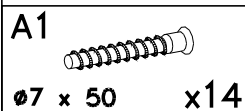
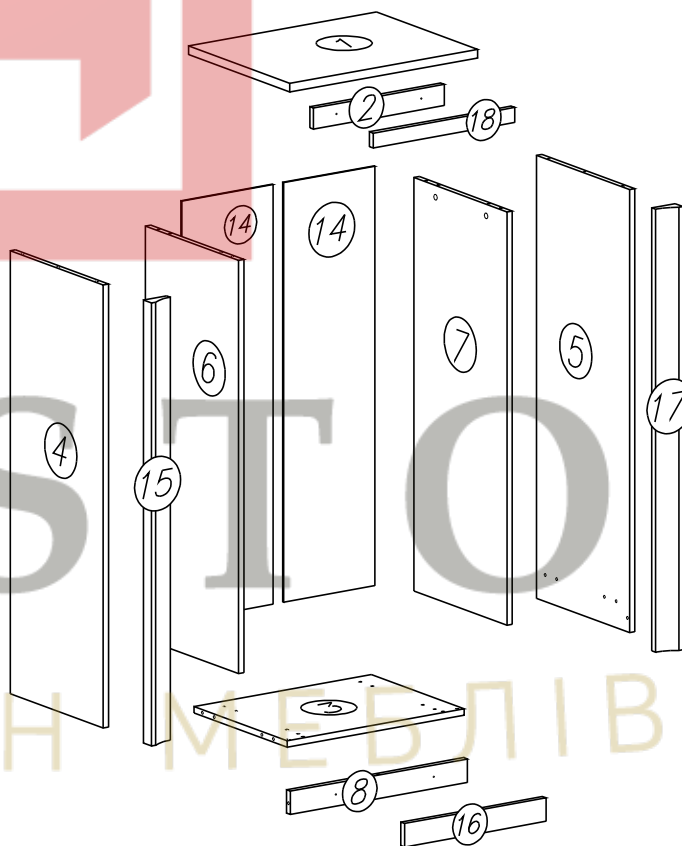
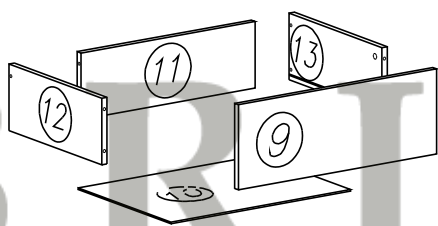

I

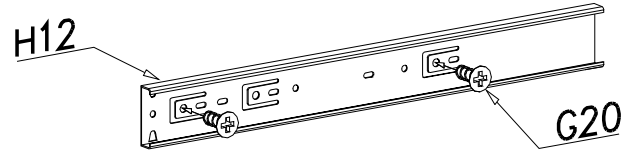
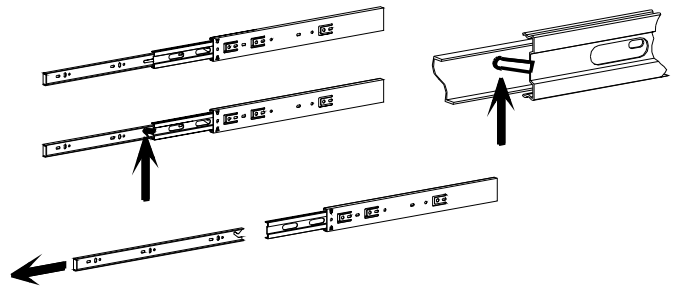
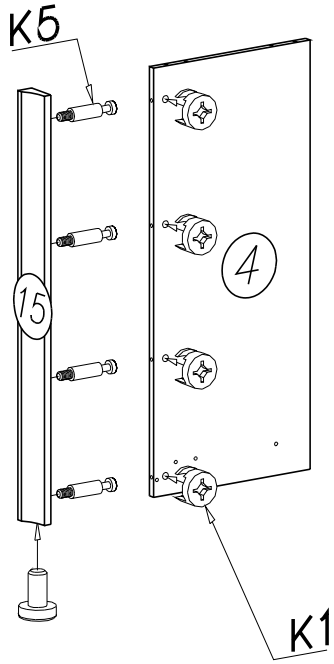

II

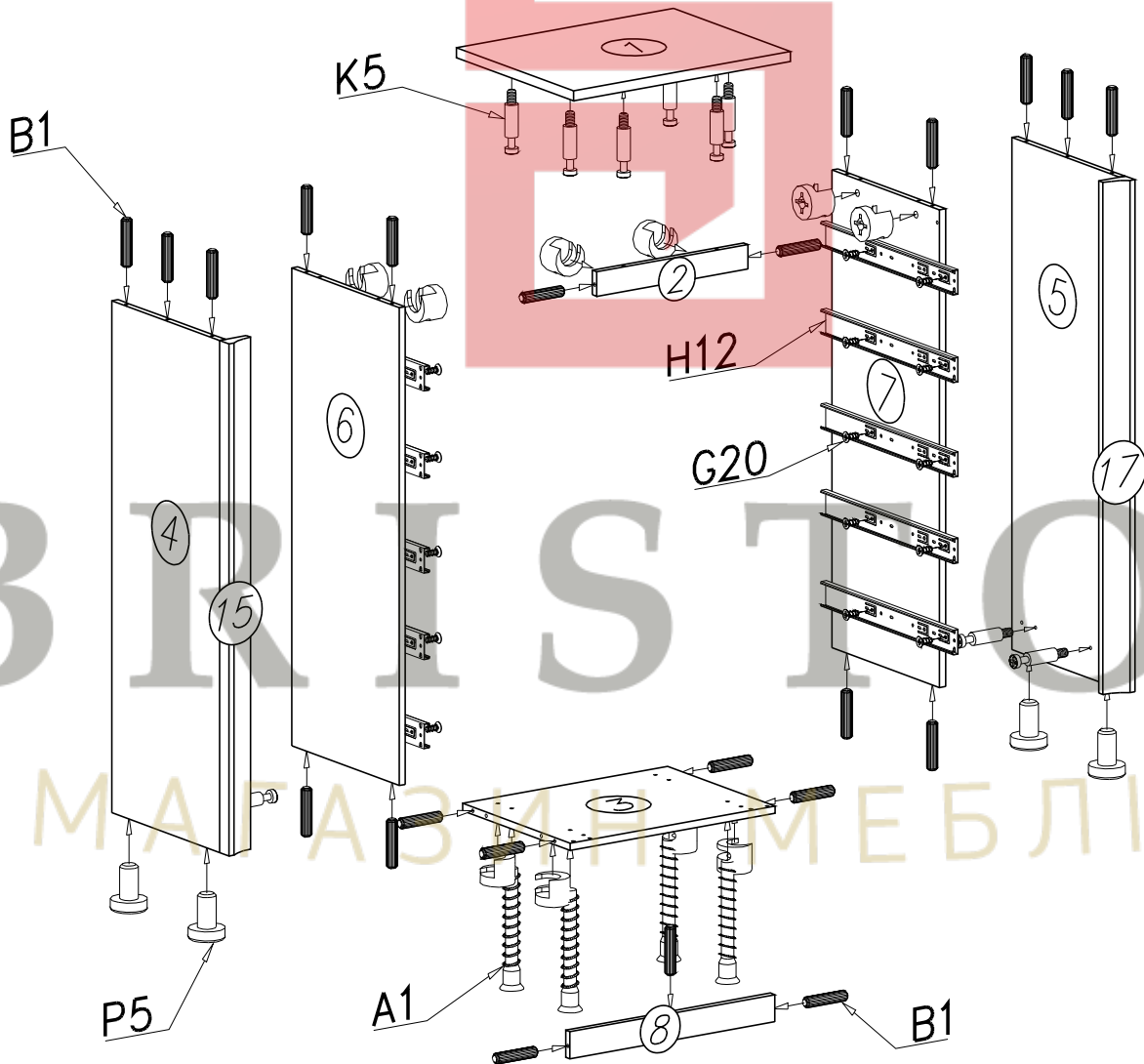

III

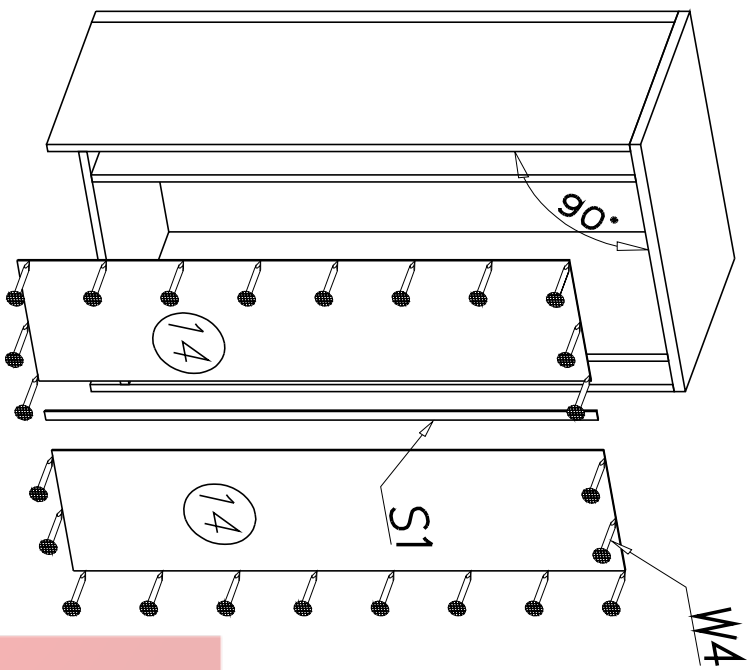

IV

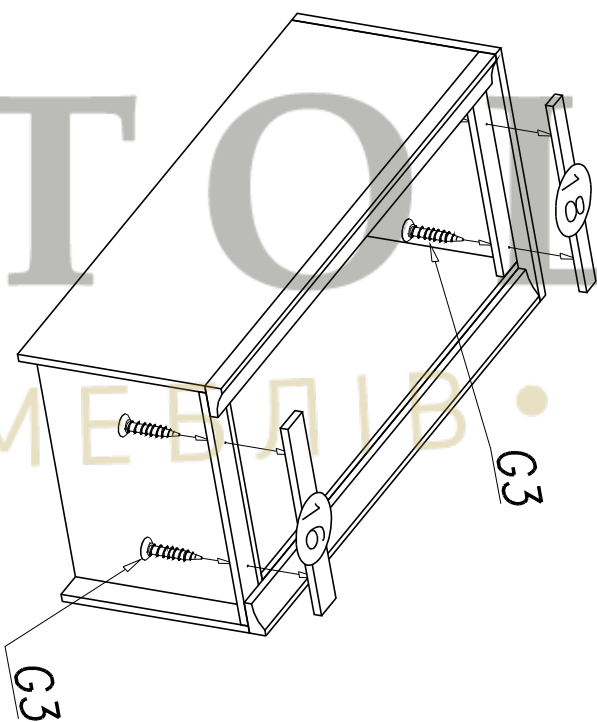

V

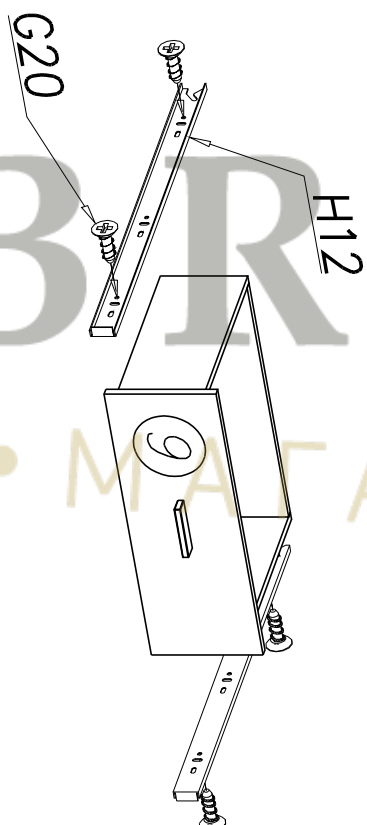
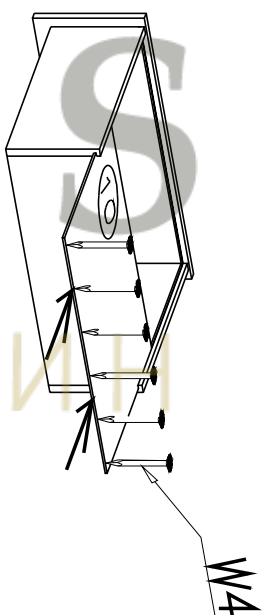
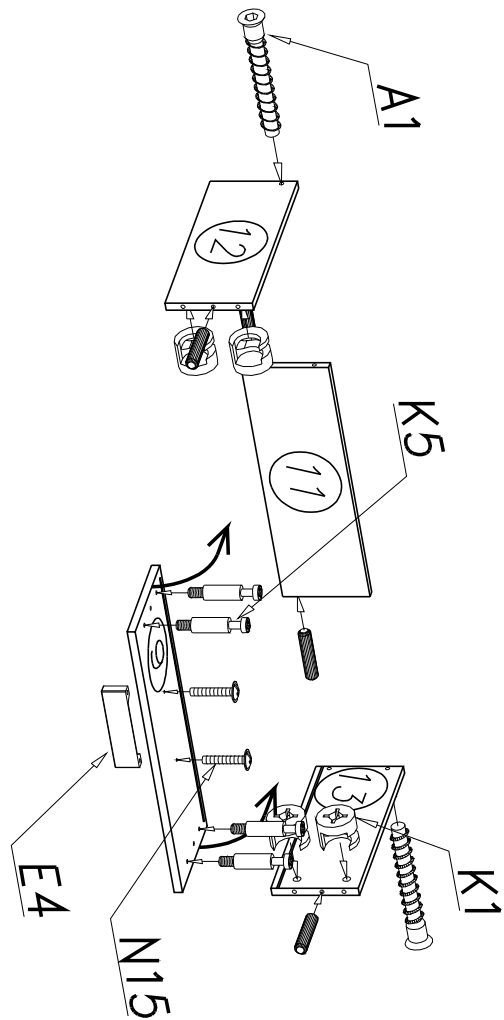

BRISTOL

• МАГАЗИН МЕБЛІВ •