

PRZED ROZPOCZĘCIEM MONTAŻU ZAPOZNAĆ SIĘ Z INSTRUKCJĄ

Narzędzia niezbędne do montażu (nie dostarczane przez producenta)

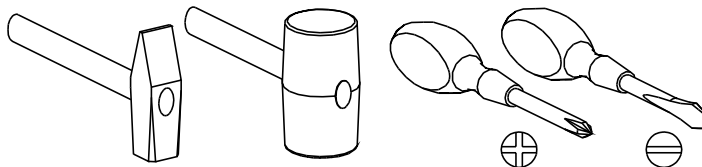
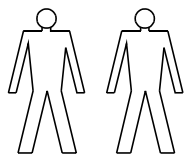

LARSA

POL/1370

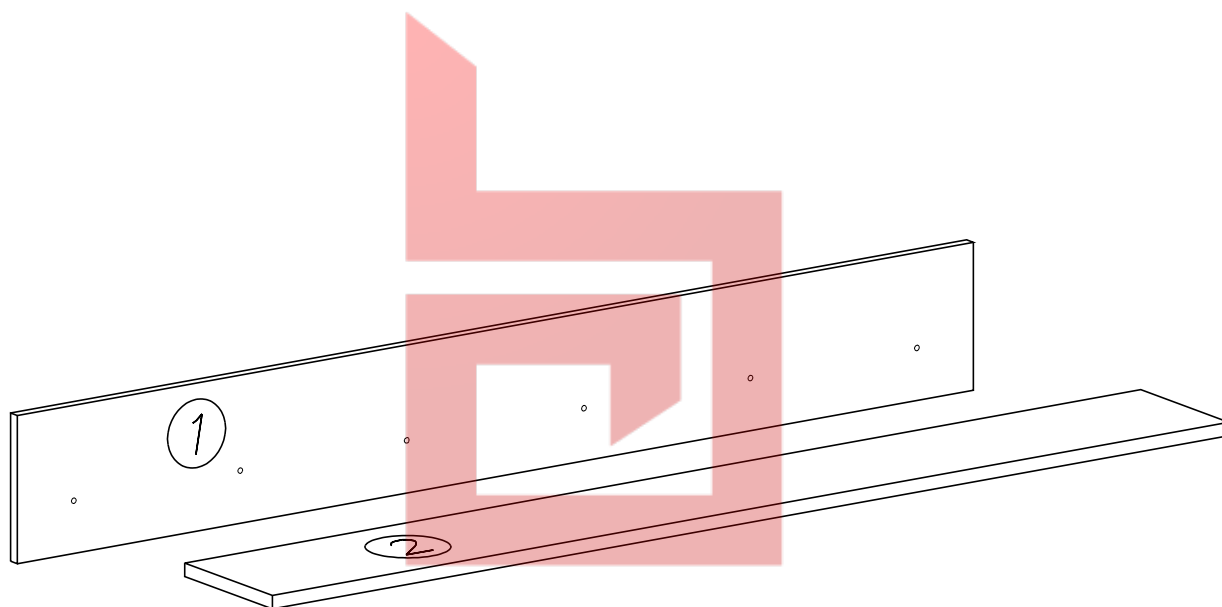
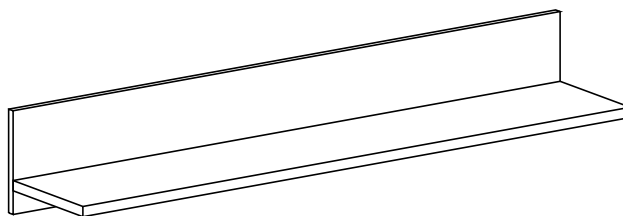

BRISTOL

• МАГАЗИН МЕБЛІВ •

Nr	Nazwa elementu	Dł [mm]	Szer [mm]	Gr [mm]	Ilość	Kod	Paczka
1	tył	1370	220	16	1		1/1
2	półka	1370	250	22	1		1/1

G6



3 x 13

x6

A1

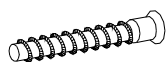

ø7 x 50

x6

U4

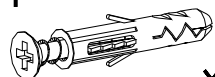

x3

U1



x3

G35



6,3 x 16

x3

W2

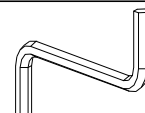

x1

1

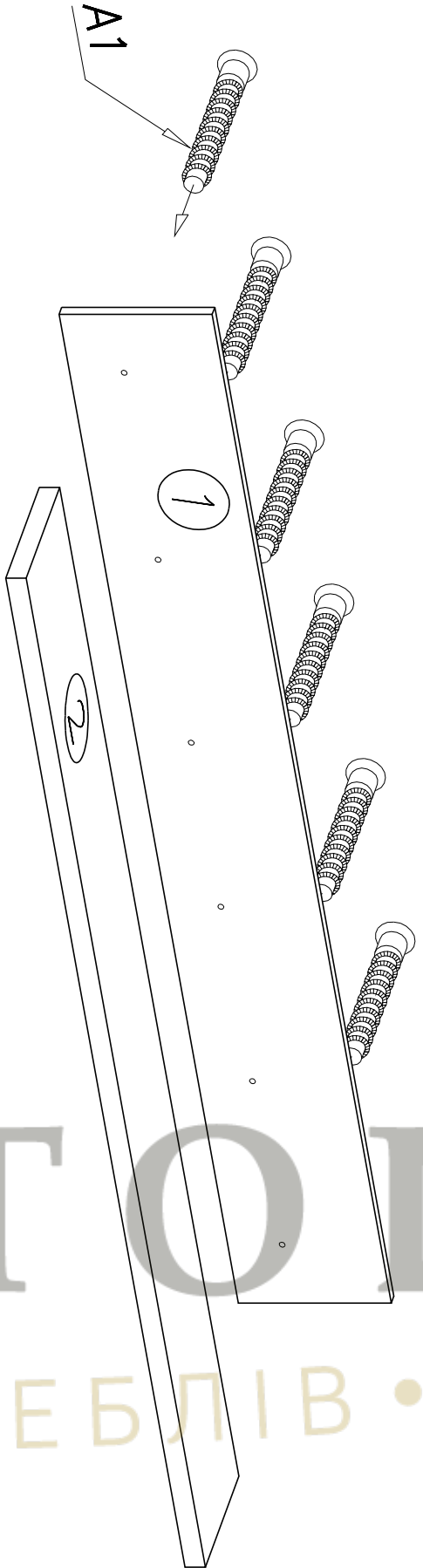

2

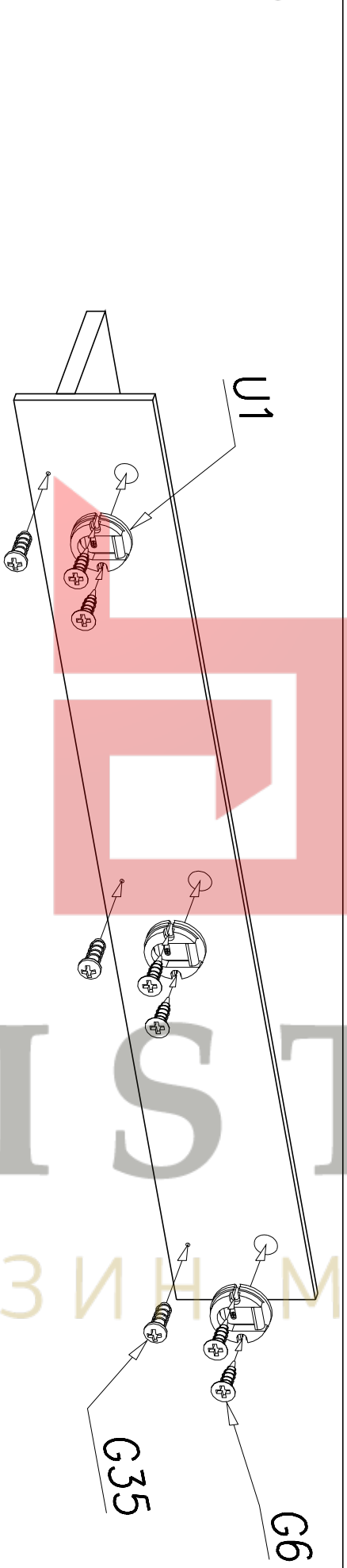

3

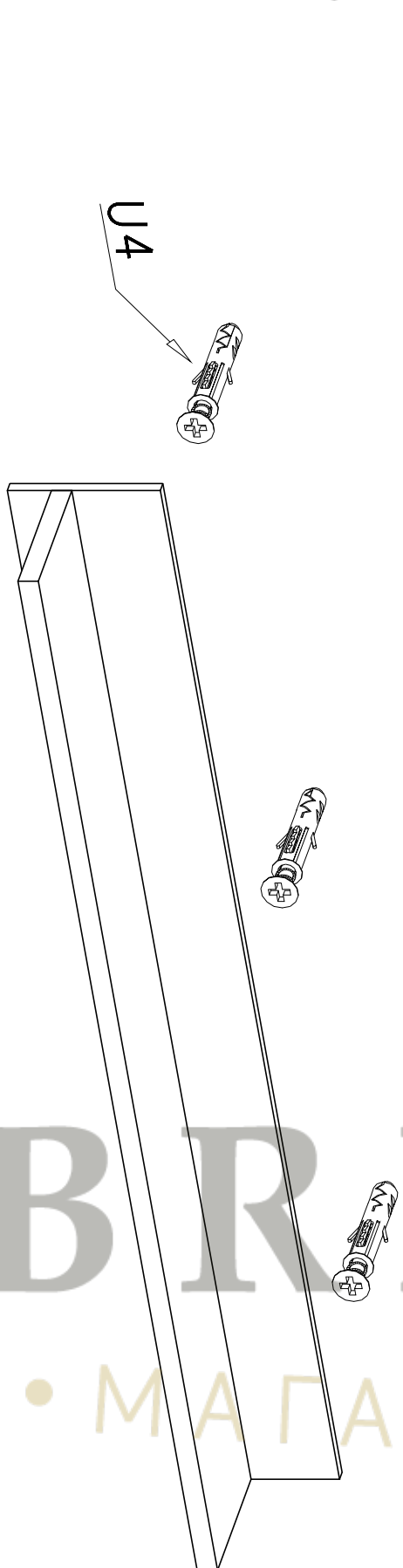

BRISTOL
 • МАГАЗИН МЕБЛІВ •