

Instalation manual

Wardrobe H11V3D

ARTE:

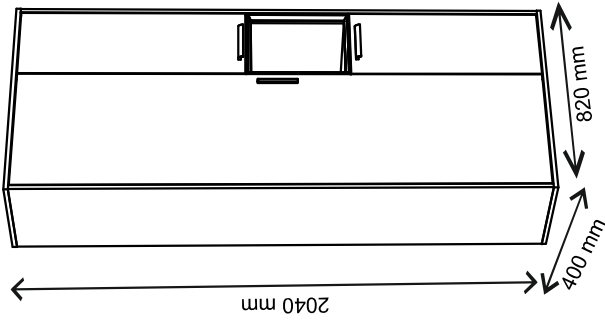
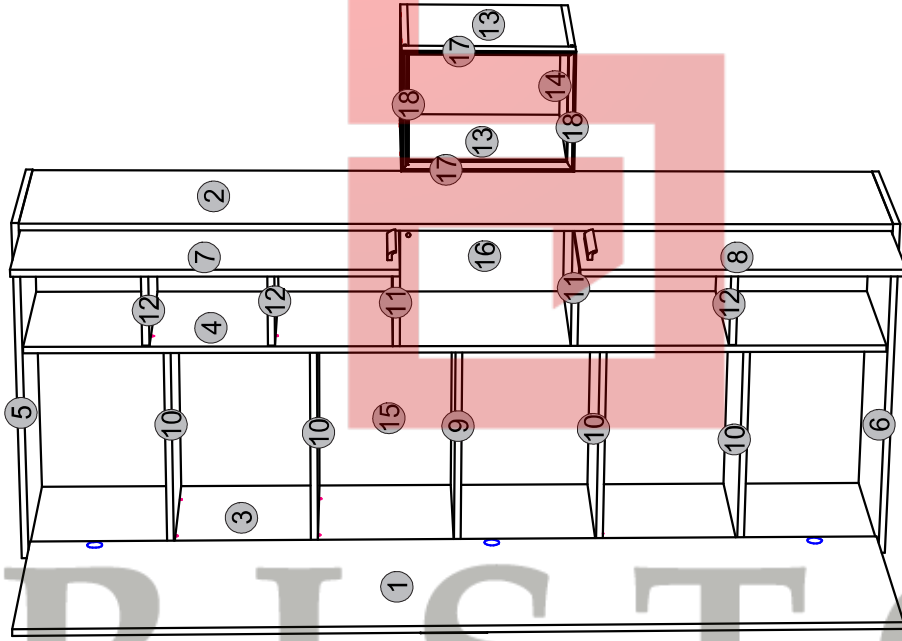
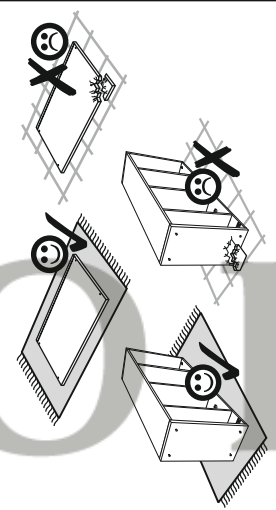
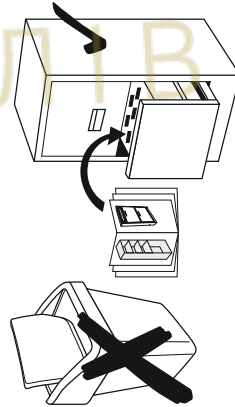
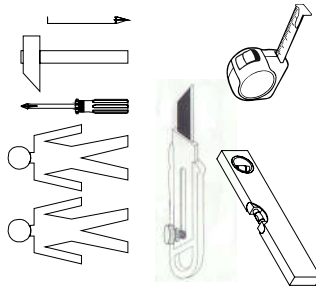
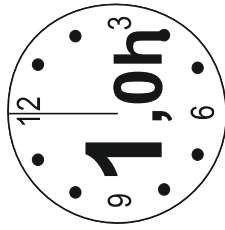
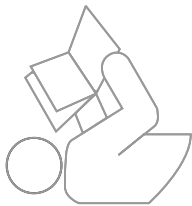

Element symbol	Dimensions			Code	Package	
	1	16	1			
1	1982	495	16	1	SZF_3D.002	3/3
2	1988	400	16	1	SZF_3D.003	1/1
3	1988	400	16	1	SZF_3D.004	1/1
4	1988	380	16	1	SZF_3D.005	1/1
5	820	400	16	1	SZF_3D.006	2/2
6	820	400	16	1	SZF_3D.007	2/2
7	852	284	16	1	SZF_3D.008	1/1
8	730	284	16	1	SZF_3D.009	1/1
9	484	380	16	1	SZF_3D.010	2/2
10	484	375	16	4	SZF_3D.011	2/2
11	286	380	16	2	SZF_3D.012	2/2
12	286	375	16	3	SZF_3D.013	2/2
13	360	356	16	2	SZF_3D.016	4/4
14	284	356	16	2	SZF_3D.018	4/4
15	2006	501	3	1	SZF_3D.001	3/3
16	2006	303	3	1	SZF_3D.015	1/1
17	392	40	16	2	SZF_3D.020	4/4
18	284	40	16	2	SZF_3D.022	4/4

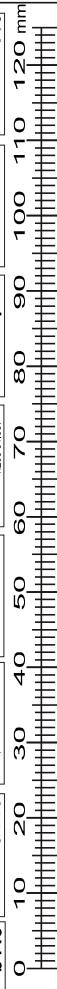
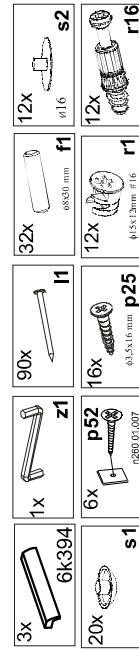
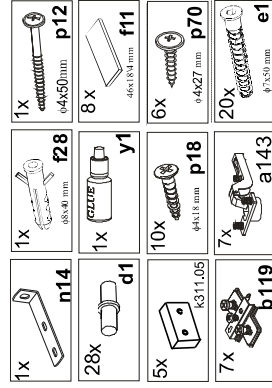

1

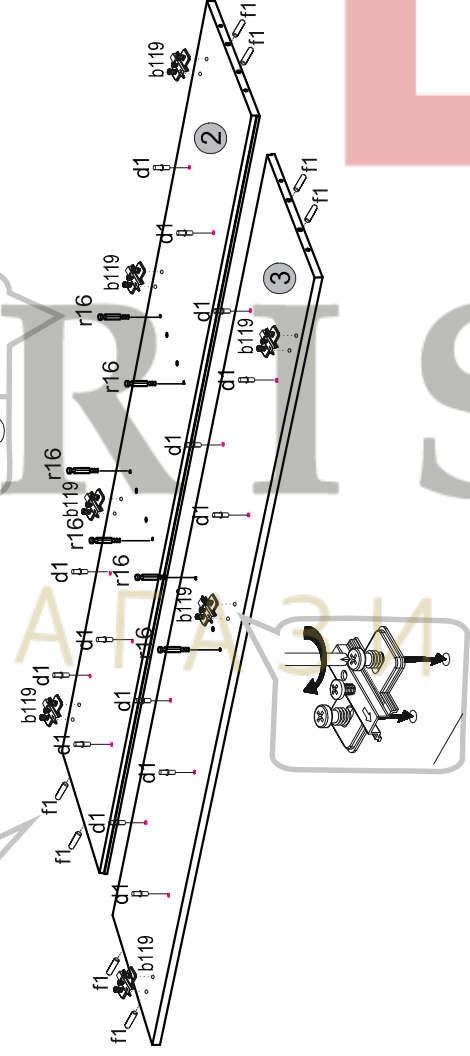
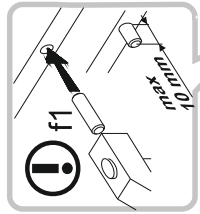

3

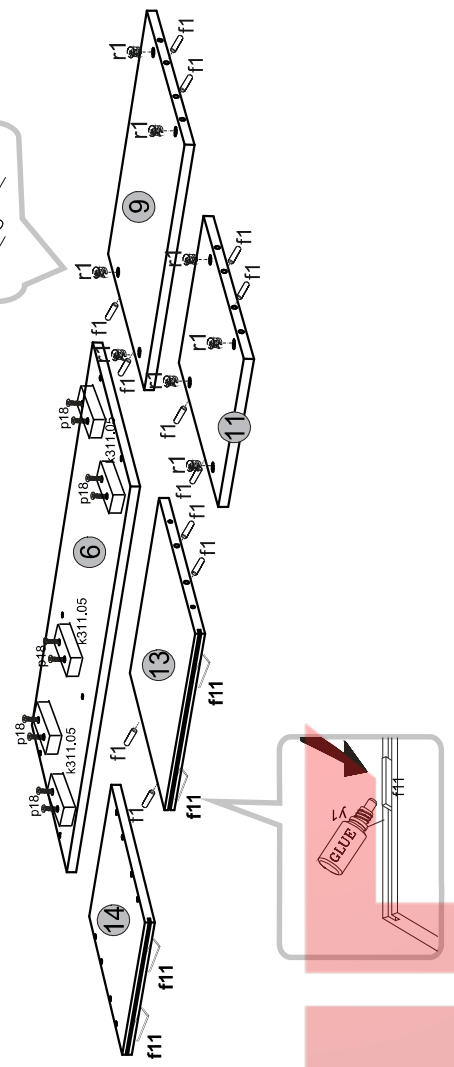
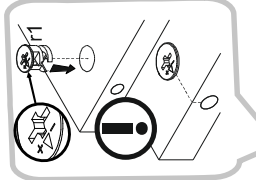

2

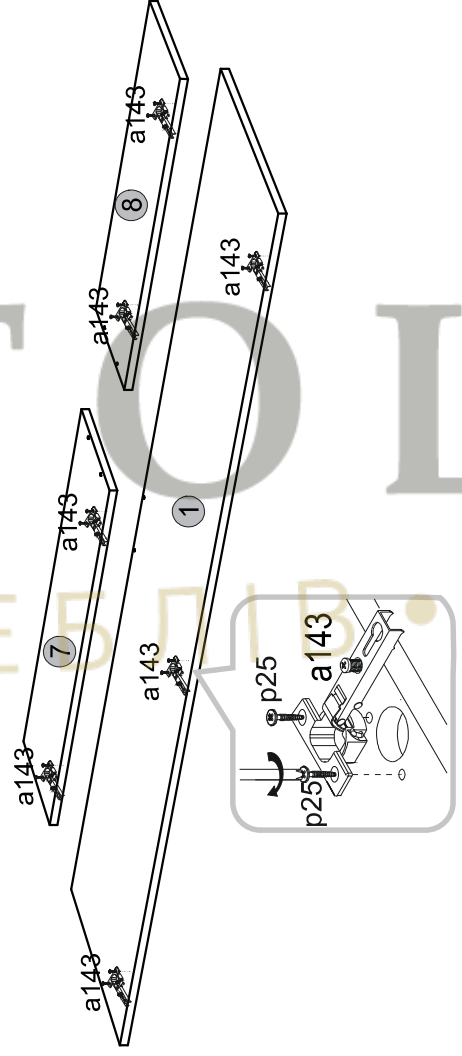

4

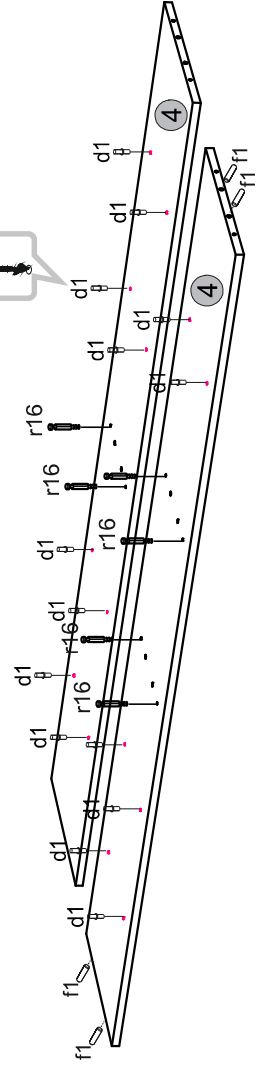
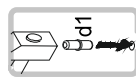

7

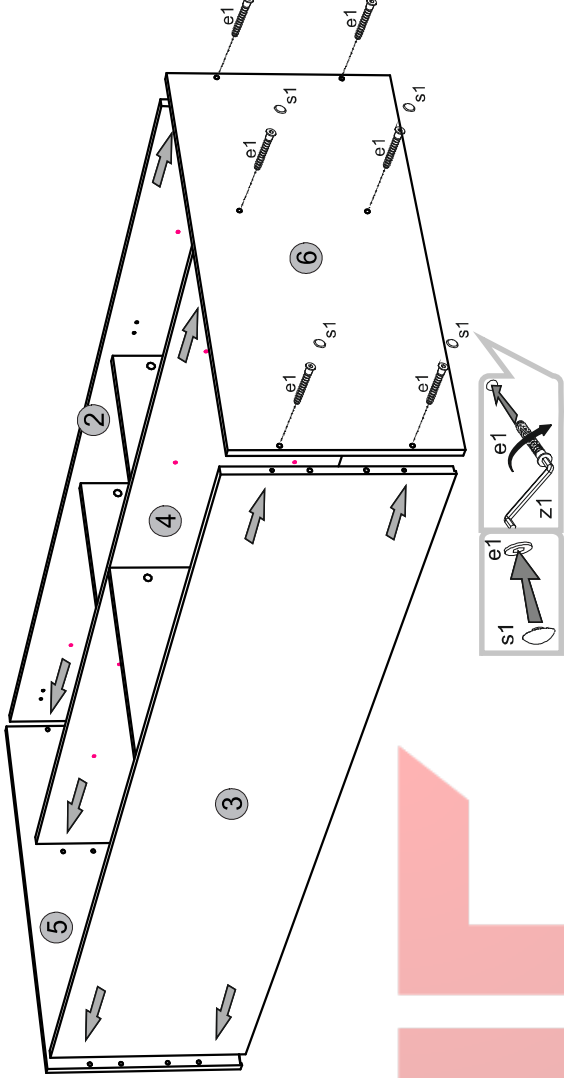

8

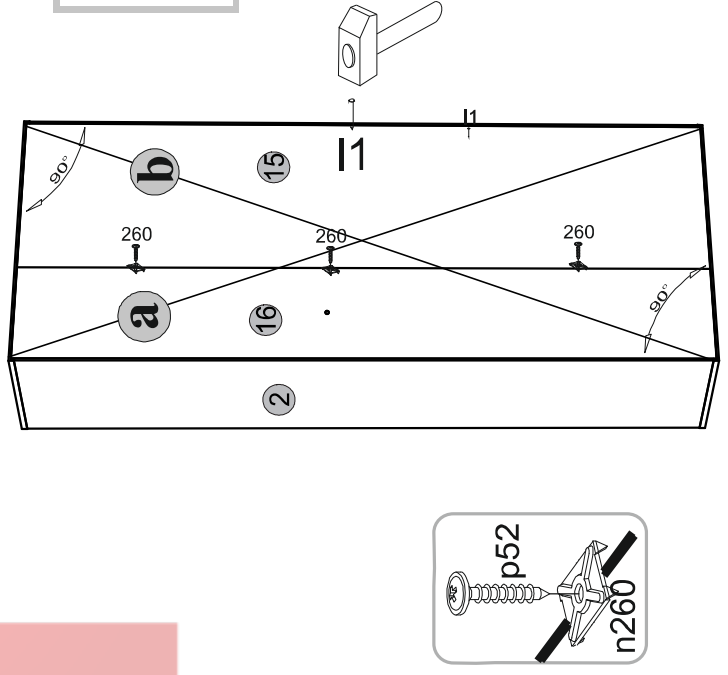

5

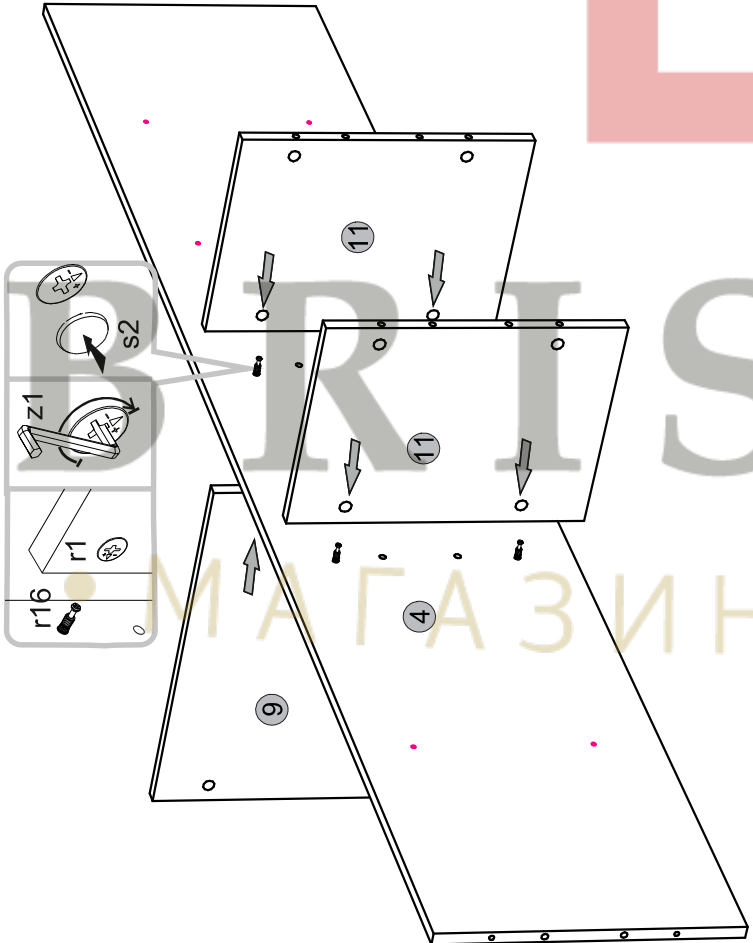

6

